

## **MONITORING OF DISPLACEMENT OF WIDE RANGE FOCUSED ON HISTORICAL BUILDINGS AND SLOPES**

**Jan Zalesky<sup>1</sup>, Pavla Voborilova<sup>2</sup>, Jan Pruska<sup>1</sup> and Jaromir Prochazka<sup>3</sup>**

*<sup>1</sup>Department of Geotechnic*

*<sup>2</sup>Department of Geodesy and Land Consolidation*

*<sup>2</sup>Department of Special Geodesy*

*Faculty of Civil Engineering, Czech Technical University,  
Thakurova 7, 166 29 Prague 6, Czech Republic*

### **Abstract**

Two projects under execution are focused on long-term monitoring of historical buildings and on research and verification of methods of slope movement monitoring. Combination of different geotechnical and geodetical methods are used. Requirements for accuracy and lifetime of site instrumentation and availability of data gathering are very different. Observational method is used to describe behaviour of historical buildings by sets of displacement data for static analyses, future numeric modelling and assessment of development of their technical state in the Prague Castle Area. Observations are provided with combination of different methods of surveying, crack and temperature measurements for longer time. These methods are enhanced by line-wise measurements using high-precision sliding micrometer and inclinometer in combined casing to assess the role of subsoil and to determine possible very slow slope movements in inclined parts of the area. Selection of model sites in North Bohemia with existing slope movements/slides was based on previous experience. Methodology of systematic approach of monitoring of slope movements is under further development using combination of set of methods. Project is focused on investigation of limits of applicability of slope stability monitoring in relation to site conditions and to assessment of slope stability and mass deformation development.

## **1. Introduction**

### *1.1 Pilot project of monitoring of the Prague Castle*

The Prague Castle is a large area variously aged of historical monuments. Some objects were observed before the project described in this paper started. Particular objects of the Prague Castle have been already monitored since year 1999. This task has been encouraged by the Static Design Office Kristek & Trcka, tended by the Prague Castle Administration Office.

Based on previous activities in the Prague Castle Area, we have been working on 3-year project called "System of monitoring of engineering conditions and predictions of their development for historical buildings and its application for the Prague Castle Area". The project has started in 2001 under support of the Czech Grant Agency. Systematic approach is used in the project. Development of a new enhanced system of monitoring is based on archive search of a foretime made reports, measured data and observed faults / displacements, measuring marks etc. Technical passports of selected buildings were made prior to the project development.

Preliminary analyses of faults were made and extension of existing monitoring system was designed to describe structure / subsoil interaction to gather relevant data for further static analyses and risk evaluation of selected buildings.

An enhanced monitoring system was designed and partially installed in 2001 and 2002. An effort of prediction of the development of engineering conditions will be based on static model of the structure of the Saint Vitus Cathedral using methods of numeric modelling in the last

phase of project execution. The first year work was focused on development of ways of site monitoring and partial new instrumentation. Methods of risk assessment will be used in combination of numeric model of the Cathedral, measured and evaluated data and modelling of the Cathedral behaviour, (Dobes et al. 2001).

Database application will be prepared for archiving and visualization of measured data, references and reports in open system.

The project execution includes a part of the Prague Castle Area consisting of Saint Vitus Cathedral and the North Wing of the Castle, but it will contribute to establish pilot monitoring system with higher knowledge of engineering conditions of buildings and data archive for long-term monitoring and care of the cultural and constructional heritage.

### *2.1 Research and verification of methods of slope movement monitoring*

Project of slope monitoring is based on previous experience and selection of two model sites in North Bohemia with existing slope movements/slides: open cast mine Chaba\_ovice and slide on the left side of the river Elbe valley above Va\_ov village. Project is focused on investigation of limits of applicability of variety of geotechnical and geodetical methods of slope stability monitoring, verification of their sensitivity, accuracy and limits of their use in relation to site conditions and to assessment of slope stability and mass deformation development. Finally, the relation of monitored data to different methods of slope stability assessment will be studied.

## **2. Start of current monitoring**

The initial observation called Zero Measurement was carried out in December 1999 and the measurement has been repeated every quarter of year and lately every half of year. The observed points are placed on sandstone pillars of the airy arcade. They are monitored by the trigonometrical method and by the precise levelling alike the St. Vitus's Cathedral mentioned below. The only one is not connected to other objects. Secondly, the indoor measurement at St. Vitus's Cathedral was started in July 2000.

Geotechnical boreholes with combined casing were instrumented in 2001 (MPD 01) and 2002 (MPD 02 and VB 011) and will be further described. Levelling measurement was connected to the MPD 01, MPD 02 and VB 011. The first linking measurement was carried out in March 2002. Then, the geotechnical instrumentation is regarded as reference points f. e. for levelling.

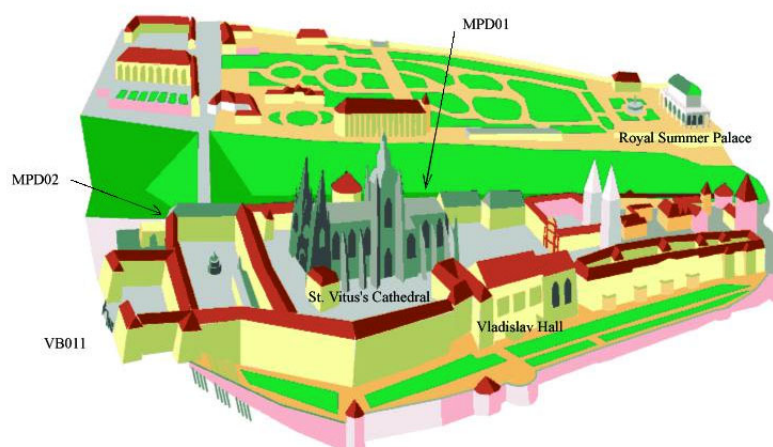

Figure 1: Monitored objects and geotechnical instrumentation in the Prague Castle Area

The connecting levelling line is led around St. Vitus's Cathedral via the first borehole MPD 01 to the Old Royal Palace, Fig. 1, further to the second bore MPD 02 and to the last bore VB 011, which is measured the first time. Later, tops of casings will be observed by the GPS method to determine their position to verify possibilities of use of GPS. These instrumented boreholes at the Castle will be related to another one located at the campus of the Czech Technical University, in front of the Faculty of Civil Engineering. The distance of the Castle to the Faculty is about 2 km.

### 3. Precise levelling at the cathedral

The site plan of points for precise levelling is illustrated on Fig. 2. There are four selected monitored sections numbered from 1 (west) to 4 (east). A horizontal plane of the point No. 15 was chosen as the indoor reference plane and a horizontal plane of the point No. 100 (opposite the cathedral) was chosen as the outdoor reference plane. Marking of the observed points is made of brazen cylinders (Fig. 2), which are screwed in brazen shrunk rings during the observation time only. Screw-threads of bench marks are 10 mm long and bench marks are 30 mm or 50 mm long. The shrunk rings are pasted into gaps, which are about 60 mm deep and 10 mm wide and were drilled to a chink between stones of a pillar. They are placed about (0.5 - 1.5) m above the tile stone floor of the cathedral. Out of the observation time, the shrunk rings are secured by covering coloured like sandstone to maintain appropriate look of the historical monument. It is important to keep the identical position of a benchmark in every measuring period, which is guaranteed by placing the numbered mark into the accordant shrunk ring and also by screwing in to backstop

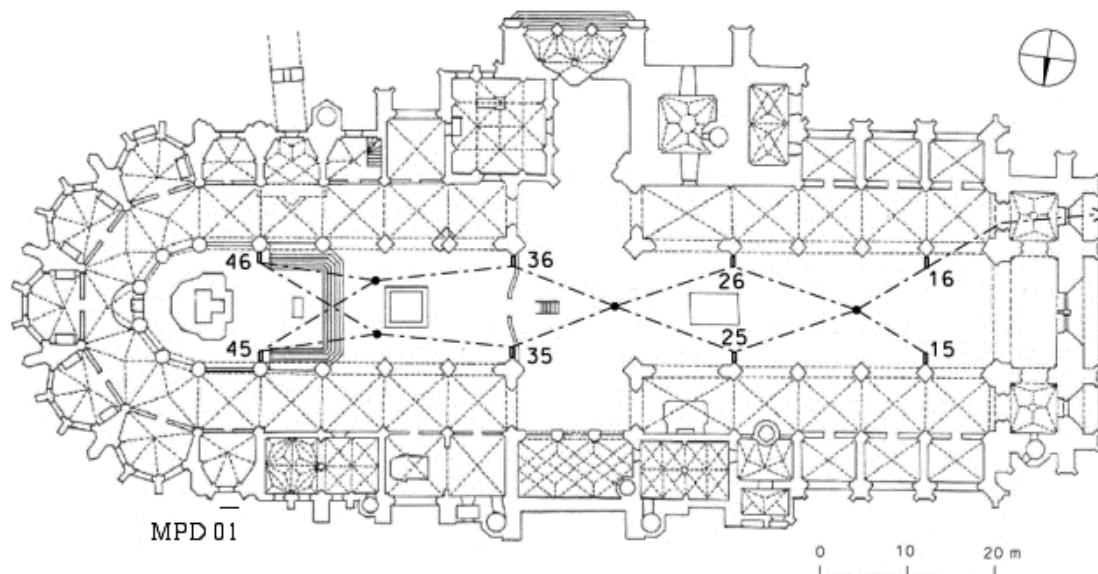

Figure 2: The scheme of benchmarks and locations of sections for trigonometric measurement and MPD 01 reference point at the cathedral

Levelling lines are measured indoors, in the cathedral on benchmarks, which is illustrated by Fig. 2. The indoor line is connected from the benchmark No. 16 to the benchmark No. 100 located on the opposite building. This benchmark No. 100 is included in check levelling lines measured around monitored objects and MPD 01. The connection to the outdoor benchmark has to be measured at first, before end of the cathedral opening hours. The others are measured

in the locked cathedral, without visitors. The precise levelling is measured with the level Zeiss Ni 007 and one 1.75 m long single invar rod with two scales and half-centimetre graduation. The same devices and the same equipment are used in all measurements.

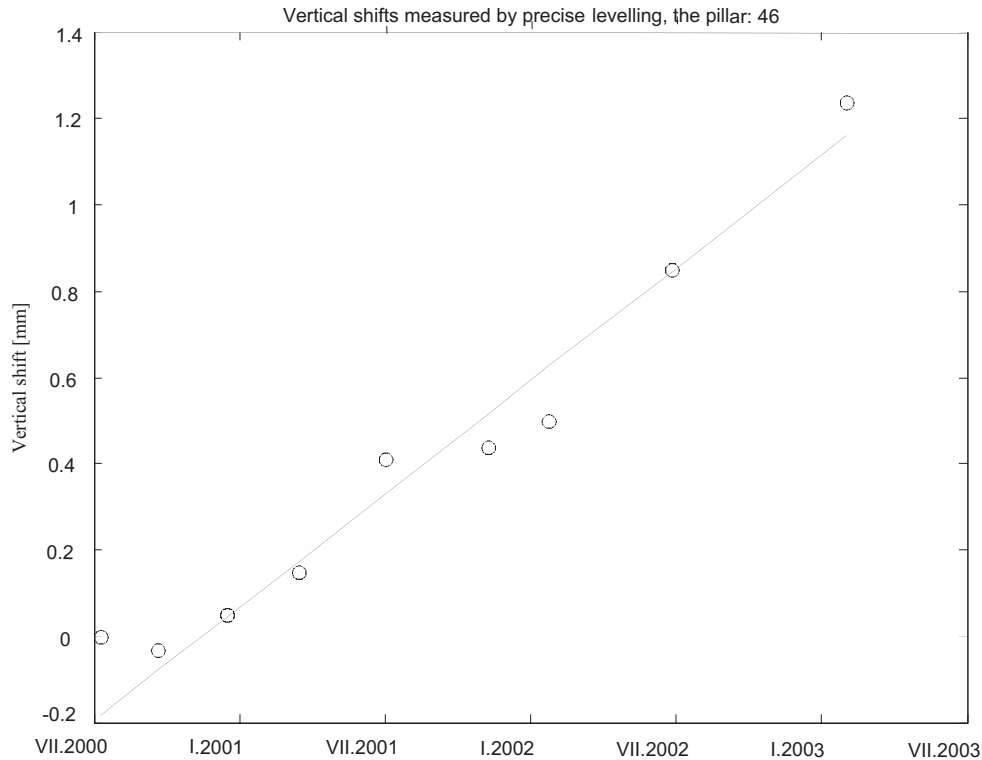

Figure 3: Estimation of annual vertical shift by regression analysis

#### 4. Trigonometrical method

Pillars monitored by the precise levelling are also monitored by the trigonometrical method. Observed points are placed at bottom and at top of a pillar. The lower points are placed max. 2.5 m above the floor of the cathedral and the upper points are about 17 m above the floor, which is only half-high than the headway at the cathedral, but it is the highest place, where geodesists could step up. Because the upper points are not simply accessible, marks of these points have been placed at the cathedral since the Zero Measurement period. The lower point marks are placed in the observation time only. The mark is an azure circle with a median bright yellow little circle.

Differences in elevations between upper and lower observed points on a pillar are computed from measured vertical angles and horizontal distances (trigonometrical method) and next differences to the Zero Measurement (vertical shifts) are calculated. Measuring is carried out by the universal electronic theodolite Leica TC 1800. It is assumed, that horizontal distances (from a standpoint to a observed point) are constant, therefore they were measured only in the Zero Measurement period.

Marking of standpoints is made of little brazen nails due to precise centring of the theodolite. The optical centring device is oriented by the same technique in every period of measurement to minimize influence of possible systematic deflection of its axis toward the vertical. Thus the centring accuracy is characterized by the standard deviation  $\sigma_c \leq 0.4 \text{ mm}$ . Expected and achieved accuracy of the measurement, values of vertical and horizontal shifts and detailed evaluation of (mainly horizontal) shifts are available in (Homepage 2003). Typical result of measured horizontal shifts is presented on Fig. 4.

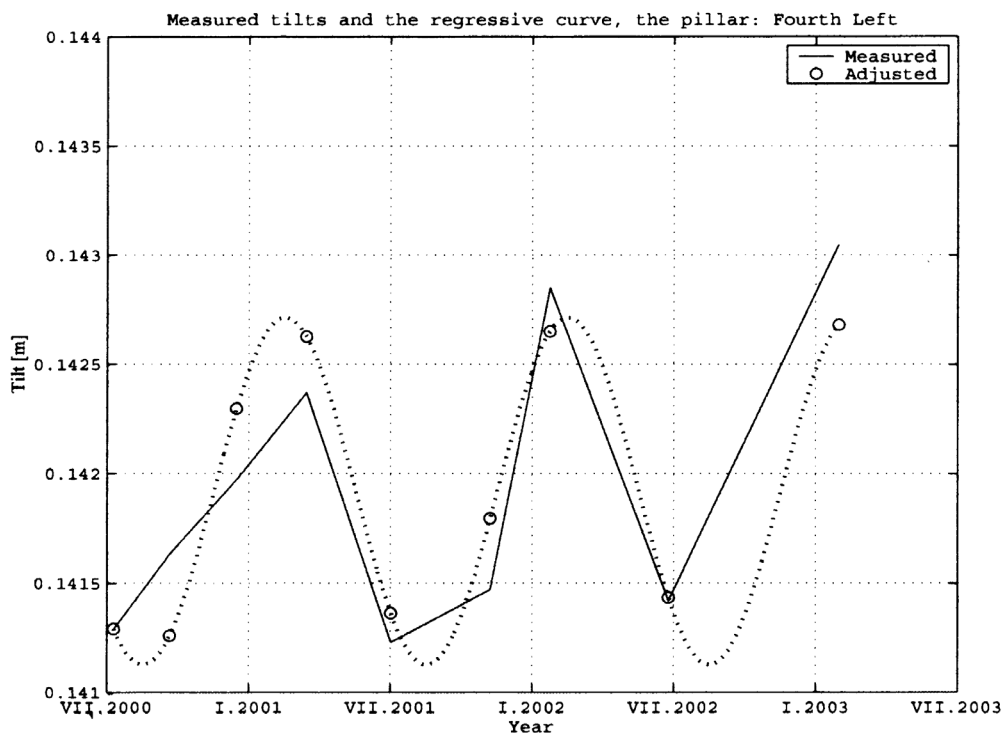

Figure 4: Horizontal shifts of pillar in section 4 left

## 5. Geotechnical Instrumentation in the Prague Castle Area

No geotechnical measurements have been done so far with sufficient cogency to describe the subsoil behaviour. Very small movements due to material properties of the subsoil, terrain and rock mass inclination probably occur in the vicinity of the St. Vitus Cathedral and especially at Mathey's pillar. Therefore borehole instrumented with combined casing for 3D displacement monitoring was made to observe deformations of the Cathedral foundation and subsoil in Vikarska Street, figure 1, borehole MPD 01 10,65 m long. At the end of November 2001, in time of boring a layer of soft rock was discovered below the footing and suspicion to slight differential settlement in section 4 (Fig. 2) was believed to be highly probable. It is too short time to make conclusions at the moment. Results of settlement measurement are presented in Fig. 4.

We assume that the Mathey's pillar, which buttress the west quoin of the west side of the North Wing of the Prague Castle, can be affected by very slow slope movement, see Fig. 1 and location of borehole Boring and installation in MPD 02 is under special requirements and was instrumented at the beginning of the year 2002 and implemented to a system of measuring points for surveying.

Measurement and applications of Sliding Micrometer made by Solexperts AG are described e.g. in Zálesky et al 2002. Combined casing with measuring marks and 4 grooves is used. Measuring marks on telescopic casing are located in origin distances of 1 000 mm. Due to connection with wall footing and subsoil by cement-bentonite grout displacements are transferred to measuring marks and displacement curve of casing. Sensitivity of the Sliding Micrometer probe is 0,001 mm/m and accuracy about 0,003 mm/m. Accuracy of inclinometer is higher of those commonly used, now extended to 0,02 mm/m. Positioning of the probe in casing is determined with higher precision using measuring marks of sliding micrometer. Extended inclinometer probe to 1 000 mm is usually used. Records of measured data and software applied on site enable immediate control of accuracy of measurements. Results obtained in MPD 01 are presented in Fig. 5.

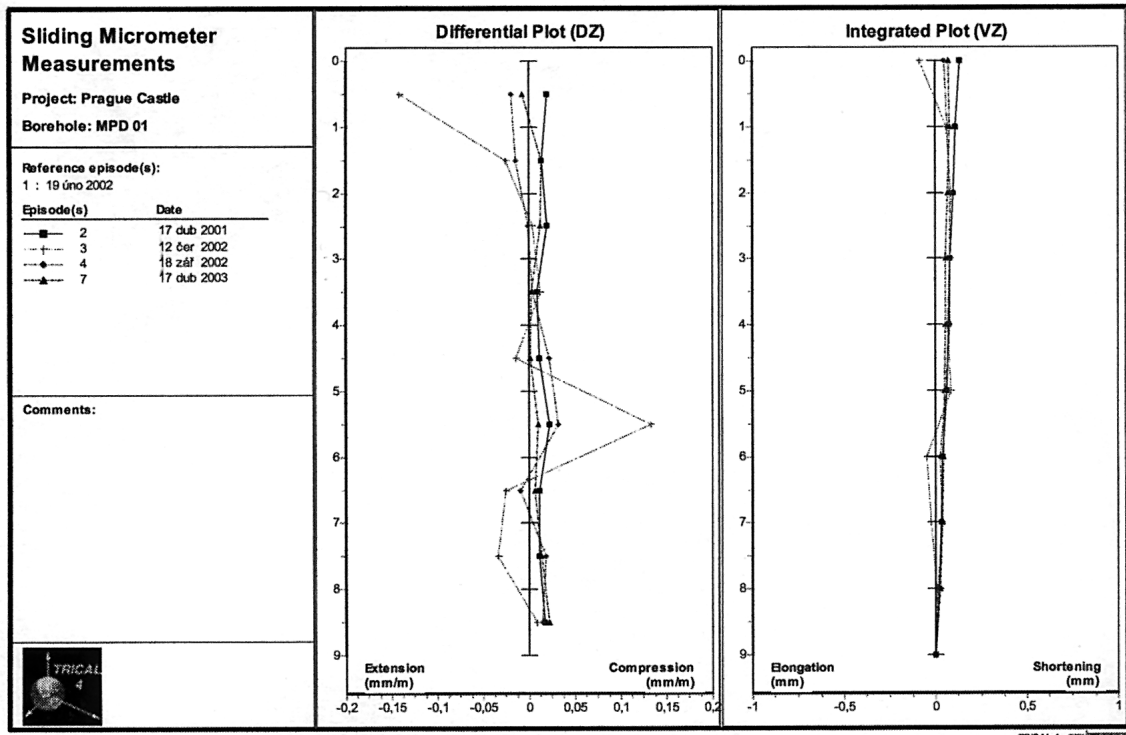

Figure 5: Axial deformation of footing and subsoil: differential and integrated

## 6. Combined Surveying and Geotechnical Measurement

A test hole TV 01 is instrumented on ground of the Faculty of Civil Engineering of the CTU in Prague. The borehole will be used for repeated testing of measurements with inclinometer and Sliding Micrometer to test available accuracy and to design, modify and approve cross connection of high-precision geotechnic and geodetic measurements including GPS technology. The instrumented borehole enables two different types of measurement. The first is performed using inclinometer and Sliding Micrometer. Lower end of casing fixed in stable rock will be presumed stable and thus there can be measured the movement of the casing top.

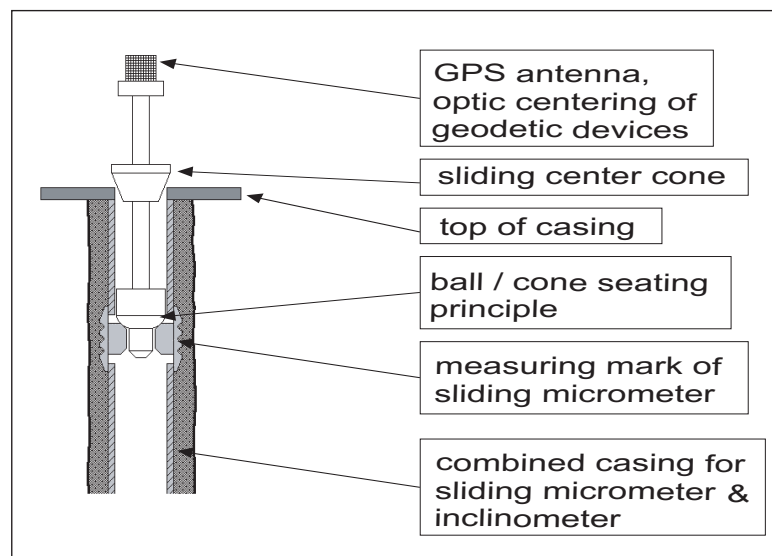

Figure 6: Insert tool to link high accuracy geotechnic and geodetic measurements

The displacements are expected to be very small in this area. The same methods will be applied in the Prague Castle Area, where movements are expected to range from very small to significant. The second type of measurement will be used as a station for the GPS and as a reference station for the measurements performed in the Prague Castle Area. On the other hand, with respect to high-accuracy of described measurements in relation to stable rock base, the type of instrumented borehole is used as a new reference point for surveying. To approve the vertical and horizontal location of the top of the casing does not take much time. With subsequent use of insert tool the reference point will be applied for surveying, Fig 6. Sliding cone was modified to ensure stability of the tool in inclined casings. Described way of use will bring savings of cost and time in surveying (Zalesky and Jettmar, 2002).

## 7. Geotechnical Instrumentation in Slope Monitoring Project

The site with different slides is located in North Bohemia on the side slope of an open cast mine under reclamation. The unstable part offers slides with different rates of sliding with different kinematics and slip zone depth in very variable inclined area.

Wide range of monitoring methods is used there:

- Combined casing for Sliding Micrometer and High Accuracy Inclinator for reference points, Fig. 7 and for Sliding Deformeter (displacement range 100 mm/m),
- Geodetic measurement using Leica TC 1800 and re-installable measuring points installed by dynamic penetration equipment,
- Standard Inclinator and casing and magnetic settlement marks,
- Pore-water pressure measurement,
- Radar interferometry – to be used in the near future (based on satellite snapping).

Selected methods of geotechnical instrumentation are used in clusters combined with geodetic measurement.



Figure 7: Reference point with insert tool in combined casing and tripod of Leica TC 1800

Assumptions about behaviour and probable slip zone location of a slope with inclination 3-5° of horizontal were based on long-term observations and records and on geotechnical site investigation. It was assumed that the slip zone is located in range 3 – 6 m below ground level. One system of sliding meets above assumptions, but one instrumented borehole was made in the upper part of the slope to approve that nothing is happening in the below zone in firm to hard clay in “stable” subsoil. This showed unexpected result of double kinematics of sliding, Fig 8, which started to develop this year and shall be further studied.

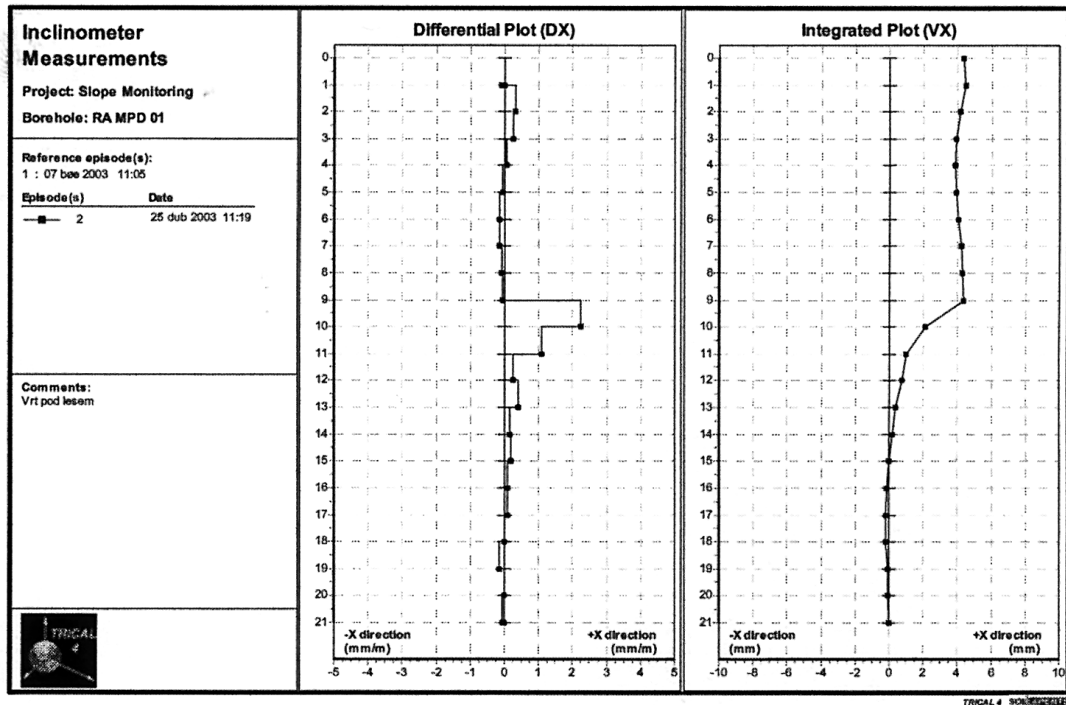

Figure 8: Unexpected inclinometer results showing a new plastic zone in deep location

## 8. Conclusions

Execution of the both projects will enable more complex approach to assessment of engineering state of historical buildings and or slopes taking into account long-term subsoil behaviour by establishment of enhanced monitoring system and more complex approach. The life cycle (lifetime) of measurements will be handled for many years because of special instrumentation of boreholes and allow to evaluate the behaviour of subsoil objectively and estimate or eliminate the slope motions as sources of strains. Equipment for geotechnical monitoring was developed to establish new type of reference points in cities and or large areas in connection to geodesy.

## Acknowledgements

The authors highly appreciate that the projects "System of monitoring of engineering conditions and predictions of their development for historical buildings and its application for the Prague Castle Area", project No. GA CR 103/01/1045 and "Research and verification of methods of slope movements monitoring", project GA 103/102/116 are supported by the Czech Grant Agency. Due to the support the paper is presented at the Conference.

## References

- Dobes C., Prochazka J., Zalesky, J. Saint Vitus Cathedral. Project of long-term monitoring of the structure stability. 2000, Kristek, Trcka and Comp., Comp. Ltd., Prague.
- Homepage (2003). URL: [slon.fsv.cvut.cz/~pavla/fig11/](http://slon.fsv.cvut.cz/~pavla/fig11/).
- Kostilkova, M (1994). *St. Vitus's Cathedral - Part II, Completion (in Czech)*. Prague Castle Administration Office, Prague, 80 p.
- Zálesky J., Jettmar, J. Notes to design and description of geotechnical elements of long-term monitoring of selected buildings of the Prague Castle. CTU Prague. Workshop 2002.
- Zálesky J., Procházka J., Pruška J.: *Geodetic and Geotechnical Long-Term Monitoring Applied for the Prague Castle Area*, Geodesy for Geotechnical and Structural Engineering, Berlin, Germany, Berlin, May 2002.